

Types of wheeling system:

F0

Composed of 2 legs with rubber feet and 2 small wheels for moving of Prestige Table by lifting it from one side. It is recommended for users who relocate their Prestige Table less frequently.

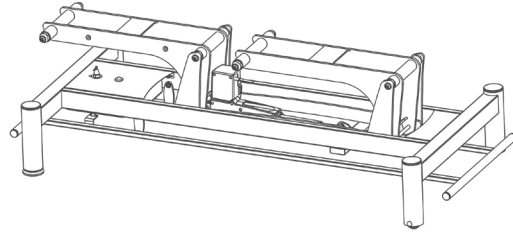

Massage tables Terapeuta SCM Prestige

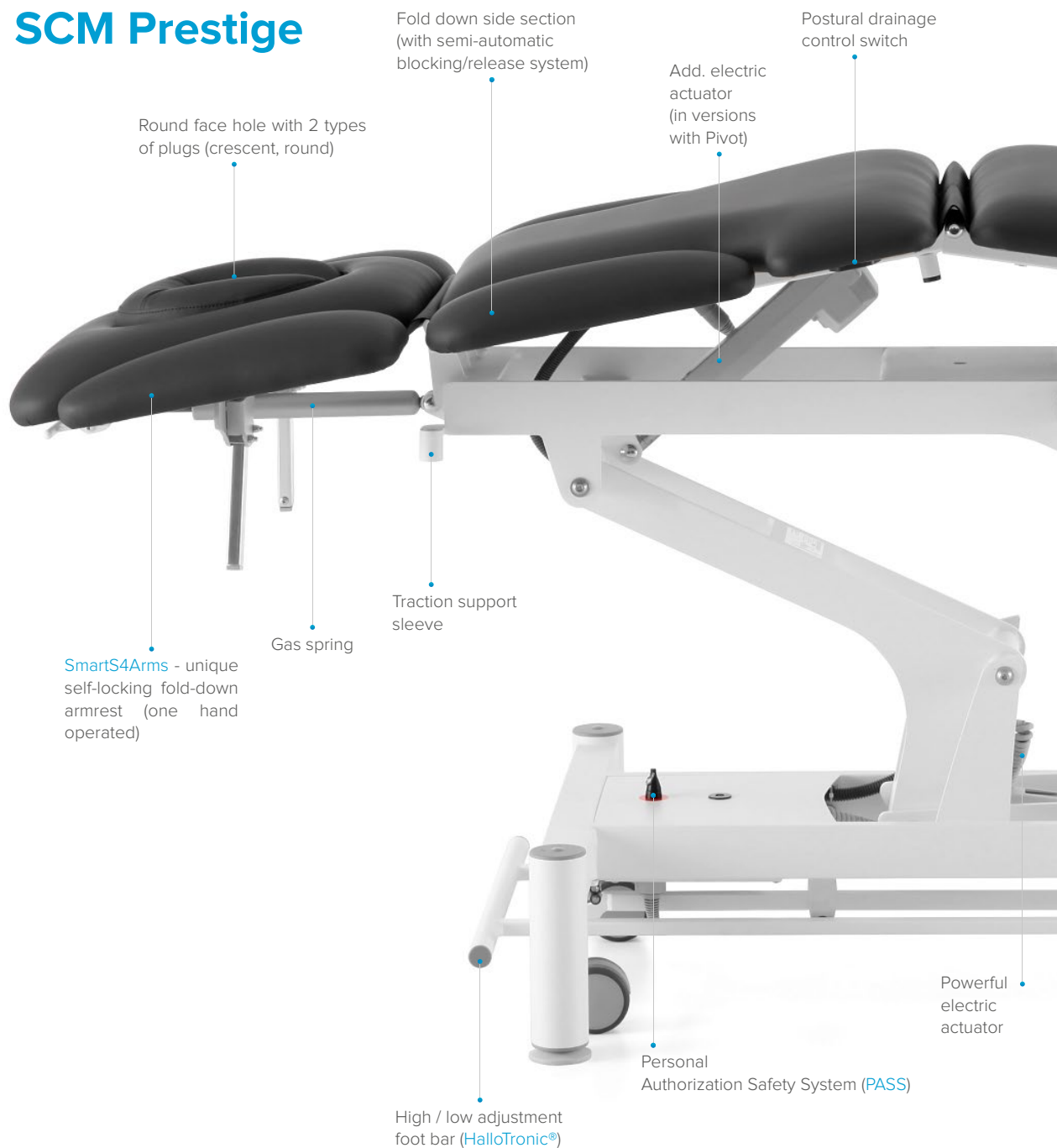

F4

Composed of 4 directional castors with central brake allows you very easy and fast relocation of Prestige Table with or without a patient.

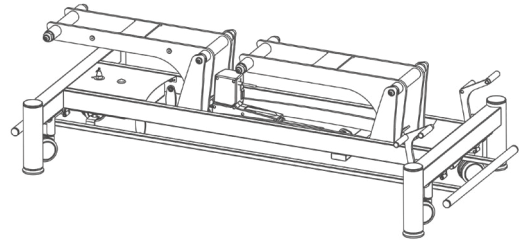

Two-layer padding with upholstery available in many colours



Release handle for gas spring system in leg section



Foot - operated lever of F4 system

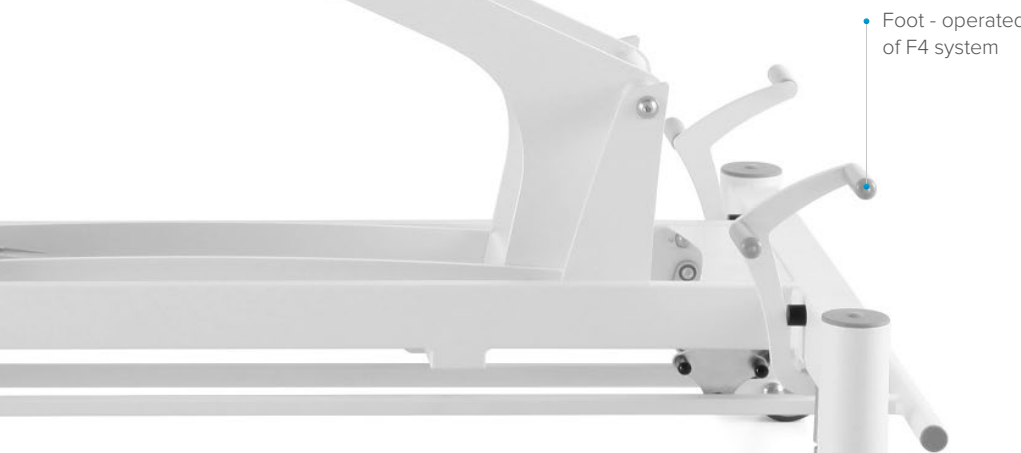

Rubber foot with 1 cm height adjustment



Years of experience

..., our individual research and passion for innovations led to creation of a stable, **reliable and extremely functional table line** for massage.

You can now enjoy the **high quality and high functionality of Terapeuta Prestige Table Line**. Just choose one of Prestige Tables which will suit your needs and the needs of your patients. We care about your opinion so if you think that something should be changed or added in the current Terapeuta Prestige Table Line please let us know what you think.

Unique features of Prestige Tables:

1. High quality upholstery!

In order to guarantee comfort of patients and high functionality for users each table has a **two-layer padding** with specially selected density of foams. After years of checking various upholstery samples, we finally found an upholstery which is:

- Non-flammable
- Bio-compatible
- Scratchproof



High quality finish

The features of upholstery together with high durability of the powder paint used for covering the metal elements will allow you to enjoy your Terapeuta Prestige Table in your practice.

There is possibility to buy couches also with upholstery made with 100% Polyurethane (**Premium Upholstery or OMEGA Upholstery**).

2. We care about your working comfort!

That's why we invented the unique **HalloTronic®** System that enables high/low height adjustment via hallotrons without the use of mechanical switches. Thanks to **HalloTronic®** System you can choose the right height of your Prestige Table without effort and noise. This solution assures the comfort of patient and comfort of work. **HalloTronic®** System allows you to adjust height of your table with help of a foot bar from each side of your Prestige Table with just a slight movement of your foot. Enjoy the benefits of your Prestige Table and unique features of **HalloTronic®** System:

- High/low height adjustment via electronically controlled actuator
- No noise during lifting
- Long life span
- Reliability
- Operated with minimal force by foot
- High/low height adjustment via shifting of bar, easily accessible from each side of Prestige Table

Prestige Tables ensure smooth high/low height adjustment with a powerful electric actuator with lifting capacity up to 225 kg.

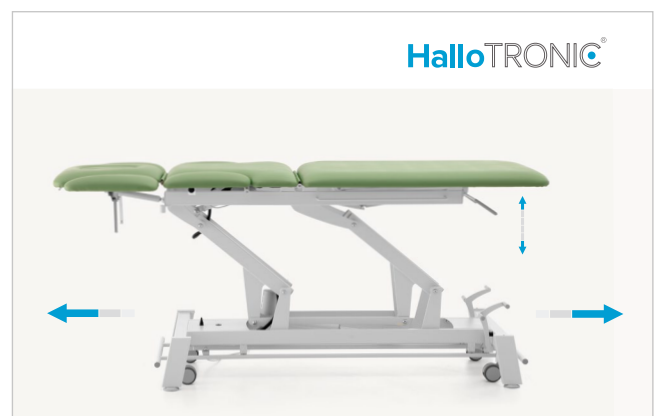

3. Wheeling systems tailored to your needs!

You can choose between F0 and F4 wheeling system. F0 system composed of 2 legs and 2 small wheels allows for moving of Prestige Table by lifting it from one side. The system is recommended for users who relocate their Prestige Table less frequently. F4 system composed of 4 directional castors with central brake allows you for a very easy and fast relocation of Prestige Table with or without a patient.

4. Easy adjustment as you wish!

Enjoy the **easy adjustment of Prestige Table's sections** with the help of gas springs. Ergonomically located and designed release handles **allow you to adjust sections of your Prestige Table the way you need** practically without any effort and with one hand. Choose postural drainage (pivot) option to allow for easy positioning of the patient in order to perform better. You are able to adjust the postural drainage via an electronically controlled actuator by easily accessible two postural drainage control switches from both sides of your Prestige Table. Unique self-locking fold-down armrest (SmartS4Arms) for a very easy (one hand operated) adjustment.



5. Guarantee your practice the ultimate safety!

All Prestige Tables have an integrated electronic control unit allowing for height adjustment and adjustment of the postural drainage option with an indication of stand-by mode (green light) and **Personal Authorization Safety System (PASS)**. Each Prestige Table is equipped with two magnetic safety keys (PASS Keys) in order to prevent unauthorized use of a table which may lead to severe accidents and compensation claims. What is more, all Prestige Tables have a **special safety system** that prevents table from folding down in case of power shortage or actuator damage.

Tables are manufactured in conformity with the certified quality management system: ISO 13485:2016.

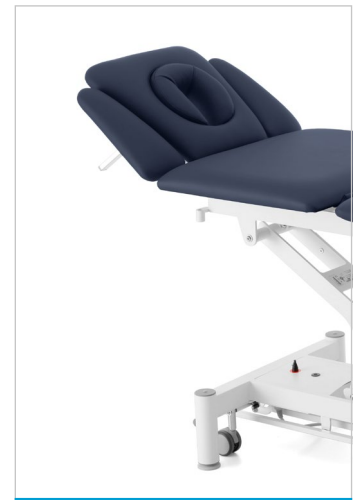

6. The devil is in the details!

All details of Prestige Tables are designed to help you in your practice, with their functionality, durability and great design. You can take advantage of **semi-automatic blocking/release system for fold-down side sections, comfortable armrests and ergonomic table top** allowing for an easy access to the patient. **Rubber feet** increase the stability. The patients can feel comfort of the **anatomical design of the face hole**. We covered screws and other protruding elements with unobtrusive plastic covers.

7. We care about the production process!

All frames are welded automatically by high quality robotic system, which makes Prestige Tables **very stable and resistant over years**. Metal parts are being covered using the most advanced technological processes in a modern powder painting line. This means that you will enjoy the high quality of your Prestige Table for years and the maintenance (e.g. cleaning) will be a pleasure.



Terapeuta SCM-4 Prestige M-S4.F0/M-S4.F4

Massage table



MD

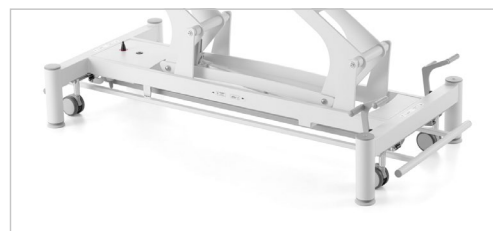

2 ways of frame painting



Box dimensions: **220 x 85 x 75 cm** Weight: **+50 kg**



Length: **202 cm**



Height: **47-95 cm**



Width: **69 cm**



Weight: **87/102 kg**



Max load*: **225 kg**

Features:

- 4-section massage table.
- Adjustable head section from -70° to +40° with a gas spring.
- Face hole in the head section with 2 removable face hole covers (round, crescent).
- Innovative self-locking fold-down armrests in head section (one hand operated) - SmartS4Arms (Smart Slide For Arms).
- Two-layer padding with upholstery in many colours.
- Powder coated, extremely stable steel frame.
- 2 side brackets for the fixation of stabilization belts and elastic bands.
- Traction support sleeves.
- Personal Authorization Safety System with 2 magnetic safety keys.
- HalloTronic® System for electric high/low height adjustment from 47 to 95 cm with a lifting capacity up to 225 kg.
- Powder coated steel high/low height adjustment foot bar accessible from each side of the table.
- Rubber feet with 1 cm height adjustment allowing for the levelling of the table.
- Two ways of frame painting: „white” or „twintone”.

Additional option:

- Built-in adjustable surface heating system.
- Upholstery of 80 mm thickness.
- Upholstery of 80 cm width.

Additional accessories:

- Paper holder.
- Wedges.
- Bolsters, semi-bolsters.
- Traction supports.
- Stabilization belts.
- Stools for therapist.

Ordering information:

M-S4.F0: 4-section massage table with wheeling system composed of 2 small wheels and 2 legs with rubber feet.

M-S4.F4: 4-section massage table with dual-lever retractable castor wheeling system composed of 4 directional castors with central brake and 4 legs with rubber feet.

* max. lifting capacity

Table articulations:

